

Article number: 20955468

Description: E+G Levelling foot
GN 342.1-50-M12-SV

Measures

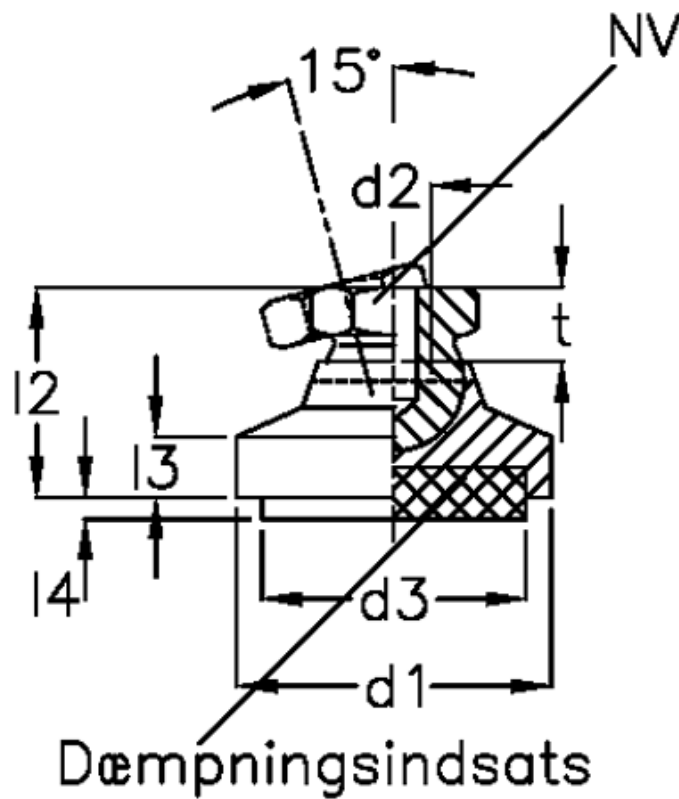

Area(m ²) damping insert	= 1809	l4 compression 0.6 N/mm ²	= 4.4
d1	= 50	Load (N) by compression 0.4 N/mm ²	= 720
d2	= M12	t	= 11.5
d3	= 48		
l2	= 30.5		
l3	= 9.0		
l4 compression 0 N/mm ²	= 6.5		
l4 compression 0.4 N/mm ²	= 5.3		